



Université du Québec
École de technologie supérieure
Department of Software and IT Engineering

The Development of International Standards for Very Small Entities: Historical Perspectives, Achievements and Way Forward

Professor Claude Y Laporte, Eng., PhD
Editor, ISO/IEC JTC1 SC7 Working Group 24
Lima, Peru
November 11th, 2009



Content

- **Introduction**
- **Need for Standards for Very Small Entities (VSEs)**
- **Establishment of ISO Working Group 24**
- **Approach used by Working Group 24**
- **Survey – technique used and results**
- **Accomplishments to Date**
- **Deployment Packages**
- **Pilot Projects**
- **Network of VSE Support Centers**
- **Next Steps**

ISO/IEC JTC 1/SC7 = International Organization for Standardization/
International Electrotechnical Commission Joint Technical Committee
1/Sub Committee 7,
VSEs = Very Small Entities are enterprises, organizations, projects or
departments having up to 25 people.

École de Technologie Supérieure (ETS)

Over 4500 students, 125 professors, 25 general senior lecturers and 200 lecturers.

About 2000 paid industrial internships in over 900 companies each year.

Undergraduate Programs

- **Software Engineering**
- **IT Engineering** →
- **Construction Engineering**
- **Production Engineering**
- **Electrical Engineering**
- **Mechanical Engineering**
- **Logistics and Operations Engineering**

- 700 students
- **17 Professors** in the department have a mean industrial **experience of 15 years.**

Graduate Programs

- **Software Engineering** →
- **Information Technology**
- **Other programs**

150 students.



Université du Québec

École de technologie supérieure

Department of Software and IT Engineering

www.etsmtl.ca

The Importance of VSEs

An Example from Japan

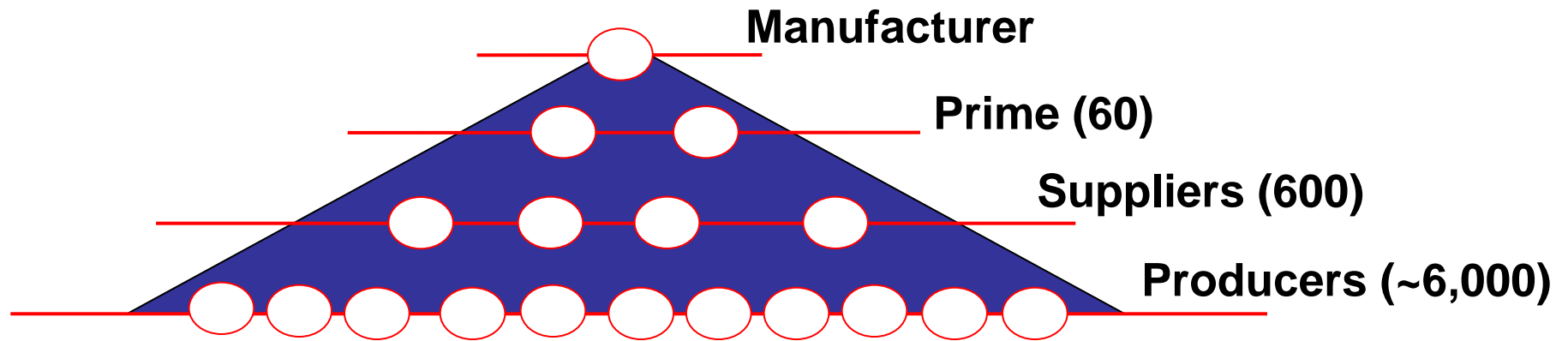

A software defect from one of the producers went into a product and resulted in a loss of over \$200 million by the manufacturer

Very Small Entities (VSEs): enterprises, departments, or projects having up to 25 people.

Size of Enterprises

- **European Union**
 - 93 % are micro enterprises (less than 10 employees)
- **Micro enterprises account for 70 % to 90 % of enterprises in OECD* countries (57 % in US)**
- **Greater Montréal Area - Software Enterprises.**

Number of employees	Number of Software Enterprises	Percentage
1 to 25	540	78 %
25 to 100	127	18 %
Over 100	26	4 %

50% of enterprises have less than 10 employees

Source: Montreal International, 2006

Development of International Standards for VSEs

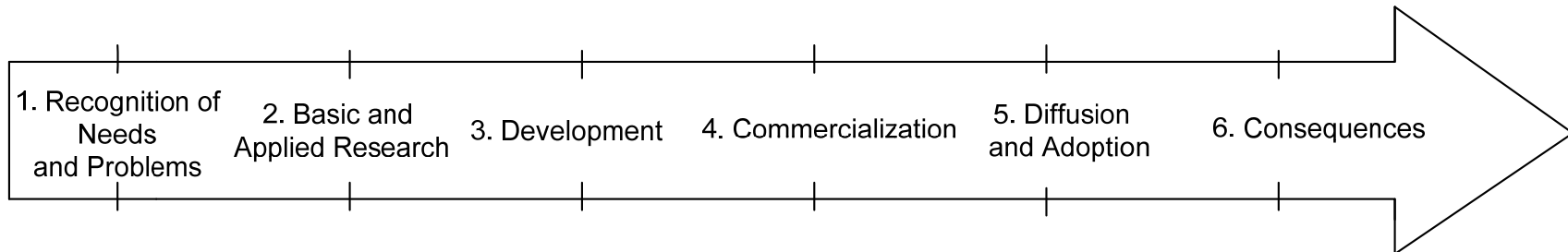

- **Phase 1 - Recognition of Needs and Problems.**
 - Began at a meeting in Australia of an ISO meeting (2004)
- **Phase 2 - Basic and Applied Research**
 - Survey of Process Improvement Initiatives (2005)
 - Survey of VSEs worldwide (2006)
- **Phase 3 - Development**
 - The Development of International Standards for VSEs (2006 - 2010)
- **Phase 4 – Commercialization (2010)**
- **Phase 5 - Diffusion and Adoption**
 - Development of the Means to Accelerate the Adoption and Utilization of International Standards by VSEs (2006 -)
- **Phase 6 - Consequences (2010 -)**

Use of SE Standards by VSEs - Hypothesis

- **Reasons for not using Standards**
 - Not written for or difficult to use by VSEs,
 - Current standards do not specifically address VSEs' needs,
 - Current standards requires critical mass (staff, budget, time) to implement,
 - Compliance with existing standards difficult to achieve,
 - Net benefit not obvious,
 - Most VSEs do not have the expertise to implement standards
- **Benefits of Use (but not seen by VSEs)**
 - Reduction of risk (business, cost, schedule, quality),
 - Enables measurement of productivity and quality,
 - VSEs are often critical component of enterprise/product.

Standards are often developed by large organisations for large organisations

Agenda

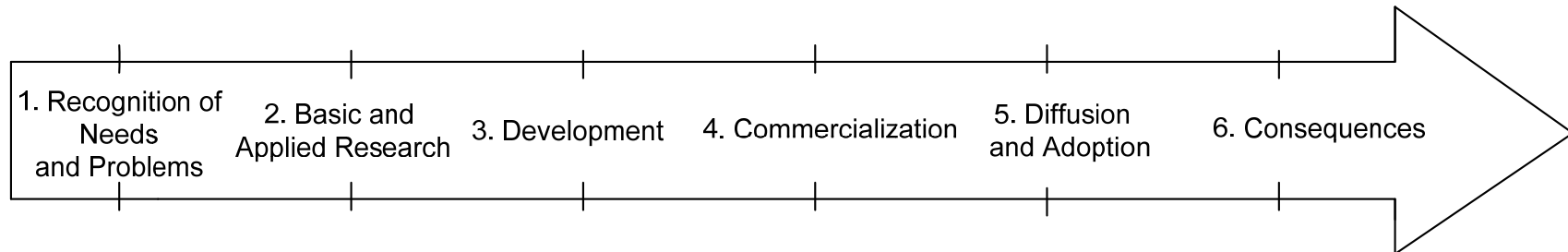

- **Phase 1 - Recognition of Needs and Problems (2004)**
- • **Phase 2 - Basic and Applied Research**
 - Survey of Process Improvement Initiatives (2005)
 - Survey of VSEs worldwide (2006)
- **Phase 3 – Development (2006-2010)**
- **Phase 4 – Commercialization (2010)**
- **Phase 5 - Diffusion and Adoption (2006 -)**
- **Phase 6 - Consequences (2010 -)**

Initiatives to help SMEs and VSEs

- **Europe**
 - Ireland - Centre for Software Process Technologies (CSPT)
 - Belgium - Centre d'Excellence en Technologies de l'Information et de la Communication (CETIC)
 - Ireland (LERO)
 - Luxembourg - Public Research Center Henri Tudor
 - UK – National Computing Center
 - European Software Institute
- **Australia** - Software Quality Institute (Rapid)
- **Latin Countries**
 - Mexico - Moprosoft
 - COMPETISOFT Project – 13 Latin American countries, Spain, Portugal.
 - Columbia – ParqueSoft Foundation
- **Asia**
 - Thailand - Association of Thai Software Industry
 - Hong Kong – Productivity Council
- **North America**
 - Software Productivity Center (SPC) - Vancouver
 - Software Engineering Institute - Improving Processes in Small Settings (IPSS)



Survey of VSEs

- **Objectives**
 - Identify VSEs' utilization of standards
 - Identify problems and potential solutions to help VSEs apply standards and become more capable and competitive.
- **Method**
 - Web-based Survey
 - Questionnaire translated in 9 languages
 - English, French, German, Korean, Portuguese, Russian, Spanish, Thai and Turkish.
 - Invitation to participate in survey widely broadcasted via:
 - WG 24 Network of contacts
 - Centers and initiatives focused on SMEs/VSEs
 - e.g., SIPA (Thailand), CETIC (Belgium), Parquesoft (Colombia)
 - SPINs (Software Process Improvement Network)
 - Affiliated/Sponsored by the Software Engineering Institute

Responses from 32 Countries

Country	Number of Responses	Country	Number of Responses	Country	Number of Responses
Argentina	2	Finland	13	New Zealand	1
Australia	10	France	4	Peru	4
Belgium	10	Germany	1	Russia	4
Brazil	72	India	57	South Africa	10
Bulgaria	3	Ireland	10	Spain	4
Canada	10	Italy	2	Taiwan	1
Chile	1	Japan	3	Thailand	59
Colombia	109	Korea (South)	4	Turkey	1
Czech Republic	3	Luxembourg	3	United Kingdom	2
Dominican Republic	1	Mexico	20	United States	3
Ecuador	9	Morocco	1		

Why don't VSEs use Standards?

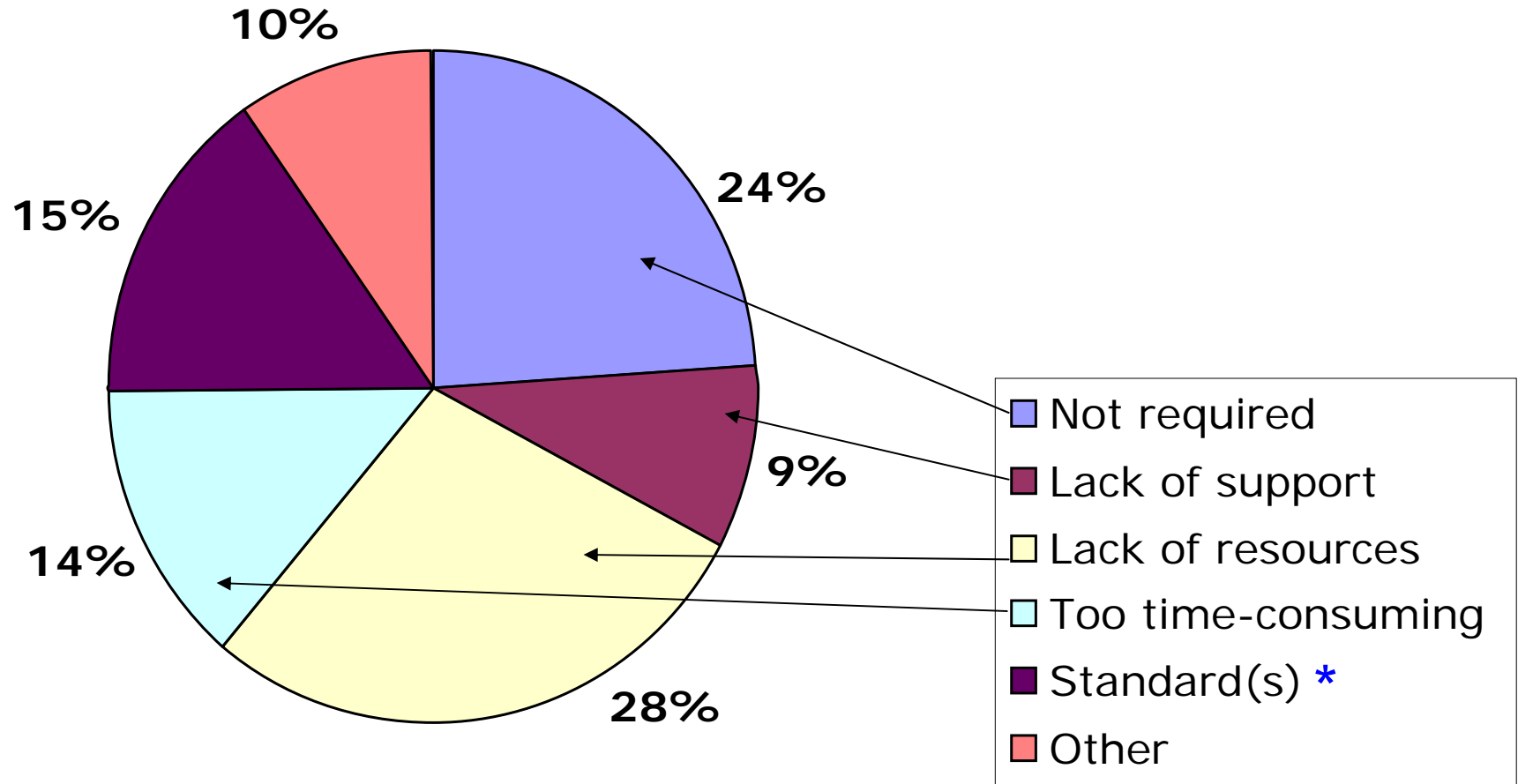

* Difficult, Bureaucratic, not enough guidance.

Requests from VSEs

- **Certification and Recognition**
 - Only 18% are certified
 - Over 53% of larger companies are certified
 - Over 74% indicated that it was important to be either recognized or certified
 - ISO certification requested by 40%.
 - Market recognition requested by 28%
 - Only 4% are interested in a national certification
- **Needs Regarding Documentation**
 - 62% are asking for more guidance and examples
 - 55% are requiring 'lightweight' standards that are easy to understand and apply and come with templates

Subset of Requirements to Develop Standards for VSEs

- R08 - Use of the set of workproduct must be affordable.
 - i.e. consultant services should not be necessary.
- R15 - The set of workproduct should provide the whole spectrum of documents
 - From standards to education material
- R29 - The set of workproduct should propose to choose a lifecycle
 - Provide examples of lifecycles
- R33 - The set of workproduct should propose definition of documents.
 - For example templates (e.g. requirements templates - use cases)
- R37 - The set of workproduct should include compliance table checklists
 - e.g. an Assessment Guide
- R52 - The guide should provide examples
 - e.g. plans, workproducts and other deliverables.
- R57 - The guide should be available free on the web

Agenda

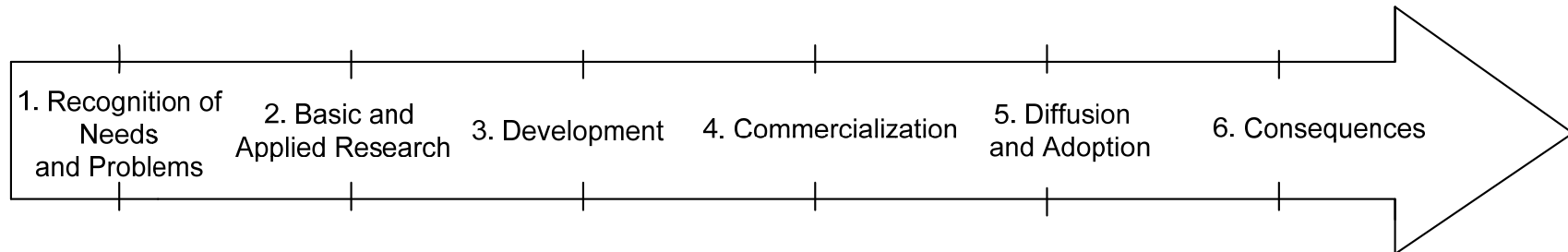

- **Phase 1 - Recognition of Needs and Problems (2004).**
- **Phase 2 - Basic and Applied Research (2005-2006)**
- • **Phase 3 - Development**
 - The Development of International Standards for VSEs (2006 - 2010)
- **Phase 4 – Commercialization (2010)**
- **Phase 5 - Diffusion and Adoption (2006 -)**
- **Phase 6 - Consequences (2010 -)**

The Strategy of WG 24 to develop standards and guidelines for VSEs

- Use the notion of ‘Profile’ to develop a roadmap and standards to meet the needs of VSEs.
 - A profile is an ‘assemblage’ from one or more base standards to accomplish a particular function.
 - A Profile Group (PG)
 - A collection of profiles which are related either by composition of processes (i.e. activities, tasks), or by capability level, or both
- Focus first on VSEs developing Generic software (Profile Group)
- Use the Mexican national standard MoProsoft as a referential to start the development of profiles
- Use two types of standards, as the input, for the development of standards for VSEs:
 - Process standards, such as ISO 12207, that define the activities required to achieve identified objectives or outcomes;
 - Product standards, such as ISO 15289, that define the structure and content of artefacts produced by the processes;
- Develop a set of documents to describe and specify the profiles

The "Generic" Profile Group

- **The "Generic" Profile Group**
 - Applicable to a vast majority of VSEs that do not develop critical software.
 - Does not imply any specific application domain

In the future new domain-specific profiles may be developed

Critical software: software whose failure could have an impact on safety or could cause large financial or social losses (IEEE 610.12)

A Roadmap in 4 Stages (Profiles) for Generic Software Development VSEs

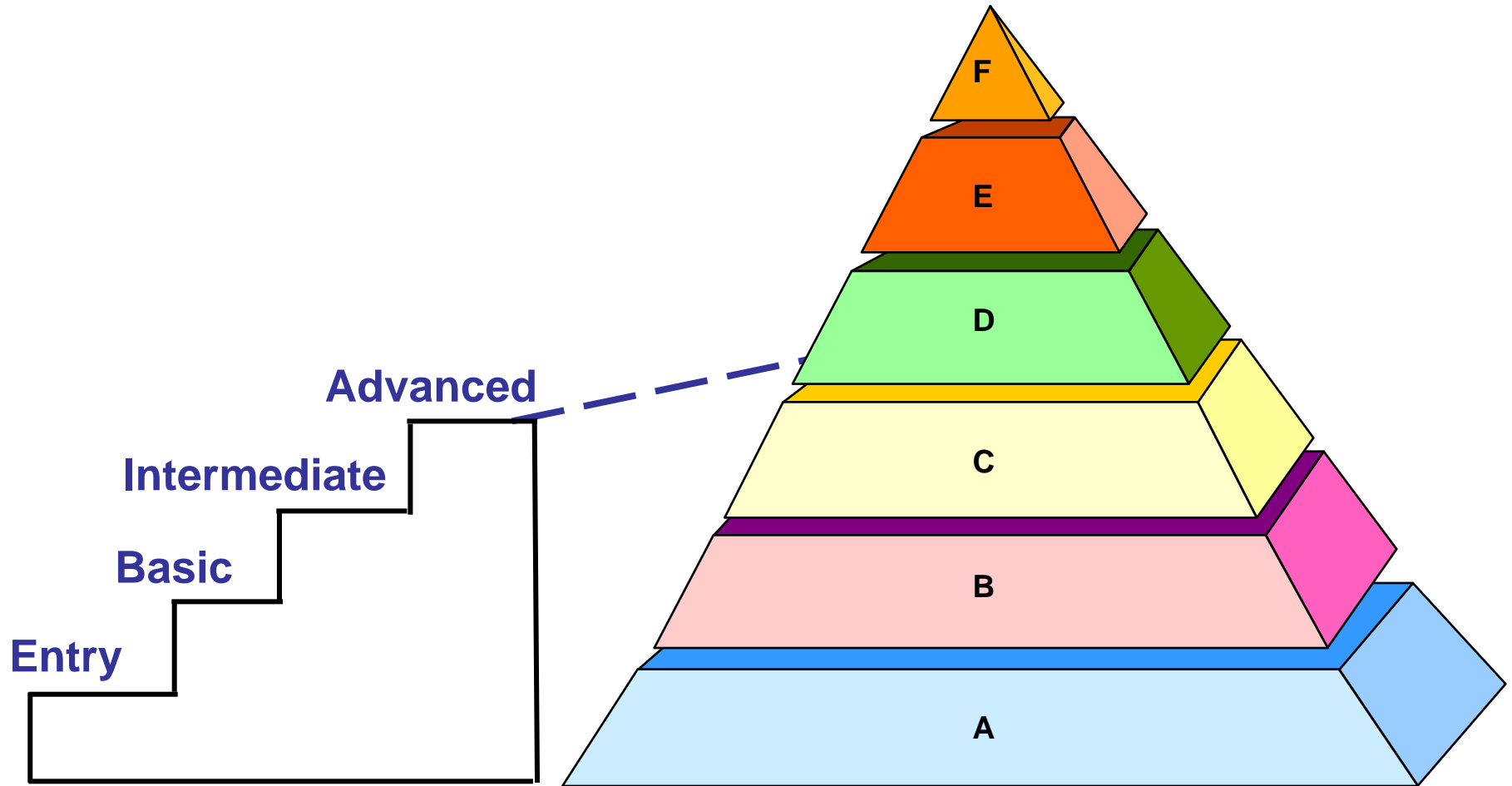

The Generic Profile Group of the ISO/IEC 29110 Standard

- **Four Profiles within the Generic Profile Group**
 - **Entry** - Targets VSEs typically developing 6 person-month projects or start-ups;
 - **Basic** - Targets VSEs developing only one project at a time;
 - **Intermediate** - Targets VSEs developing more than one project at a time;
 - **Advanced** - Targets VSEs wishing to put in place business management practices and portfolio management practices

Profile Group	Profile Name
Generic	Advanced
	Intermediate
	Basic
	Entry

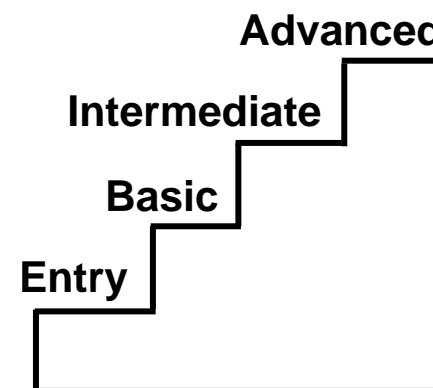

Preparation Steps for the Basic Profile

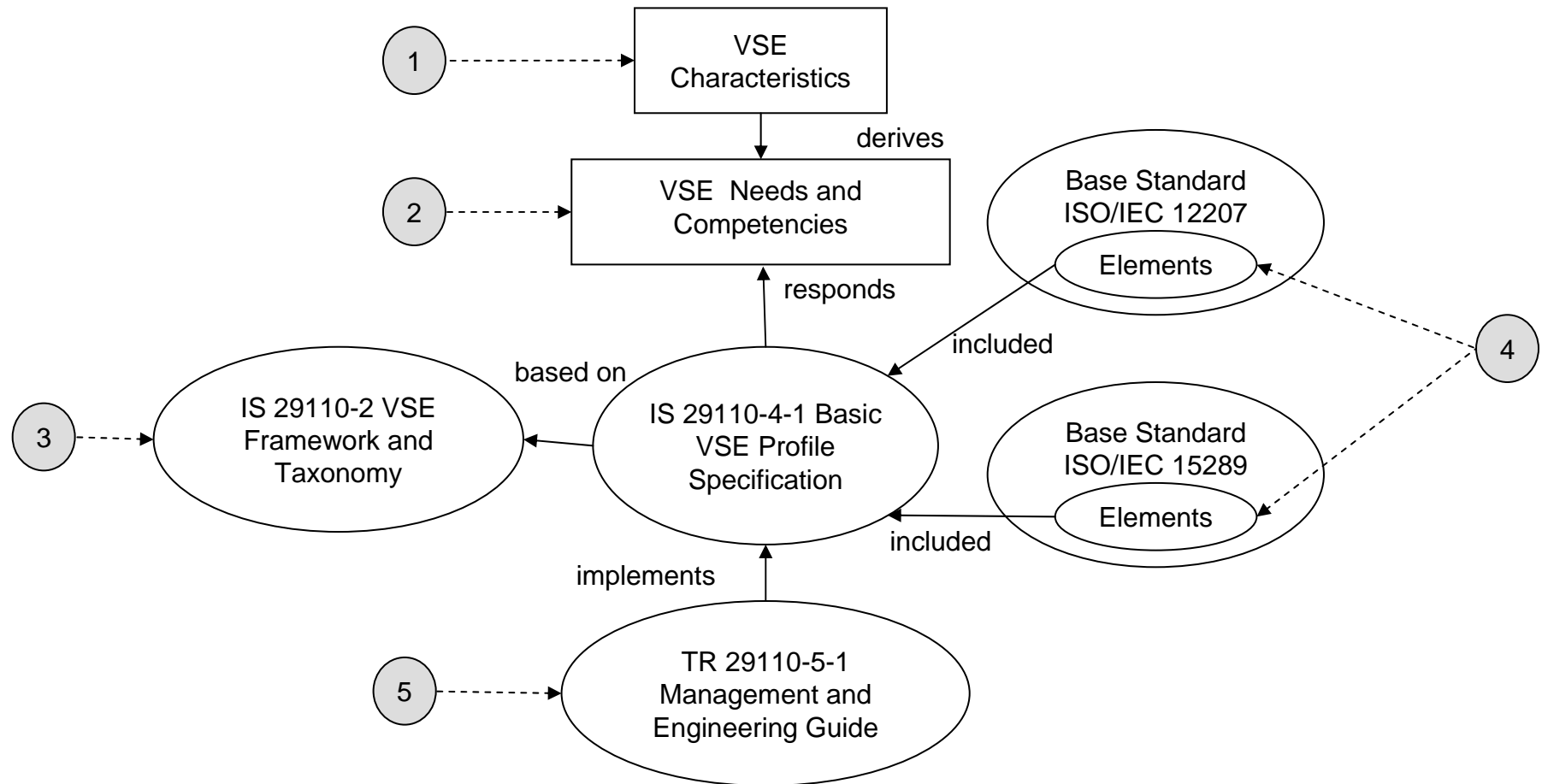

Set of 29110 Documents Targeted by Audience

29110 Overview (TR 29110-1)

For VSEs

29110 Profiles (IS)

Framework and Taxonomy (IS 29110-2)

Specifications of VSE Profiles (IS 29110-4)

**Specification - Nnnn VSE
Profile
(IS 29110-4-x)**

For Standard producers,
tool vendors,
methodology vendors

29110 Guides (TR)

Assessment Guide (TR 29110-3)

For Assessors
and VSEs

Management and Engineering Guide (TR 29110-5)

**Management and
Engineering Guide – Nnnn
VSE Profile
(TR 29110-5-x)**

For VSEs

ISO/IEC 29110

Documents Targeted by Audience

- **General Documents (applicable to all profiles)**
 - **Part 1- Overview** (Technical Report)
 - Introduces the major concepts required to understand and use the suite of documents
 - **Part 2- Framework and Profile Taxonomy** (Standard)
 - Specifies the elements common to all profiles (structure, conformance, assessment) and introduces the taxonomy (catalogue) of 29110 profiles.
 - **Part 3 -Assessment Guide** (Technical Report)
 - Describes the process to follow to perform an assessment to determinate the process capabilities and the organizational process maturity
- **Documents for the first Profile (i.e. specific to Stage 2)**
 - **Part 4-1 -Specifications** (Standard)
 - Provides the composition of a profile, provide normative links to the normative subset of standards
 - **Part 5-1 Management and Engineering Guide** (Technical Report)
 - Provide guidance on its implementation and use of a profile
 - Deployment Packages (DP)

ISO/IEC 29110 Part 5-1

Management and Engineering Guide

- Part 5 provides a Management and Engineering Guide for the VSE Profile described in ISO/IEC ISP 29110 Part 4.

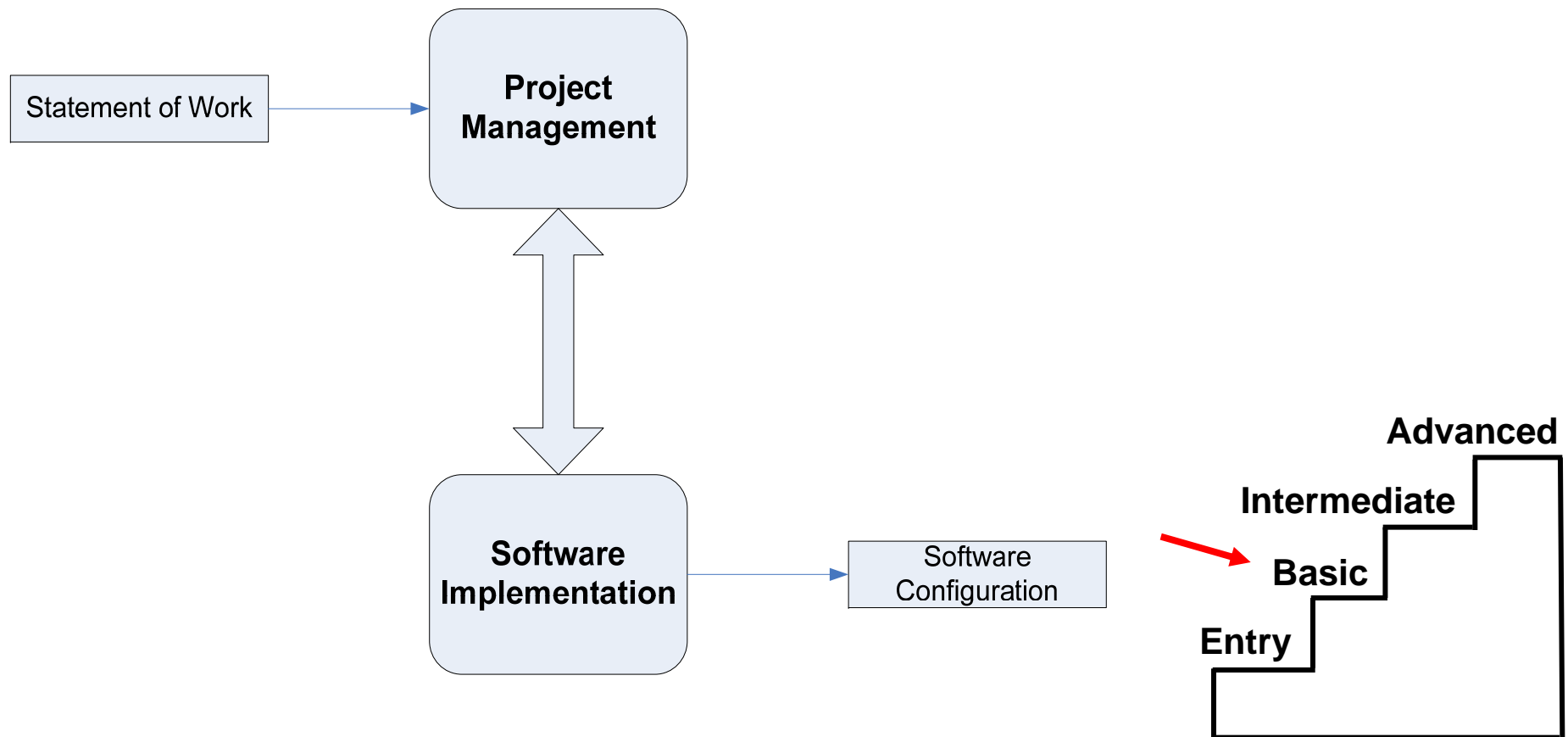

Part 5 - Project Management Process – 4 Activities

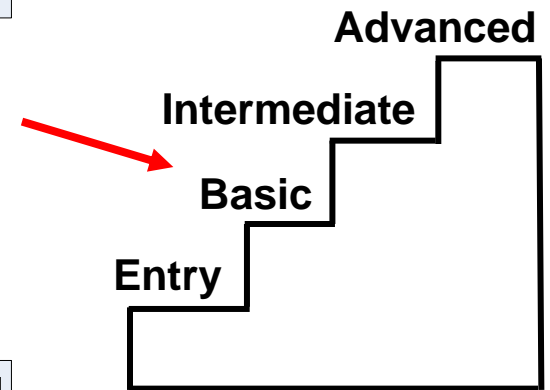
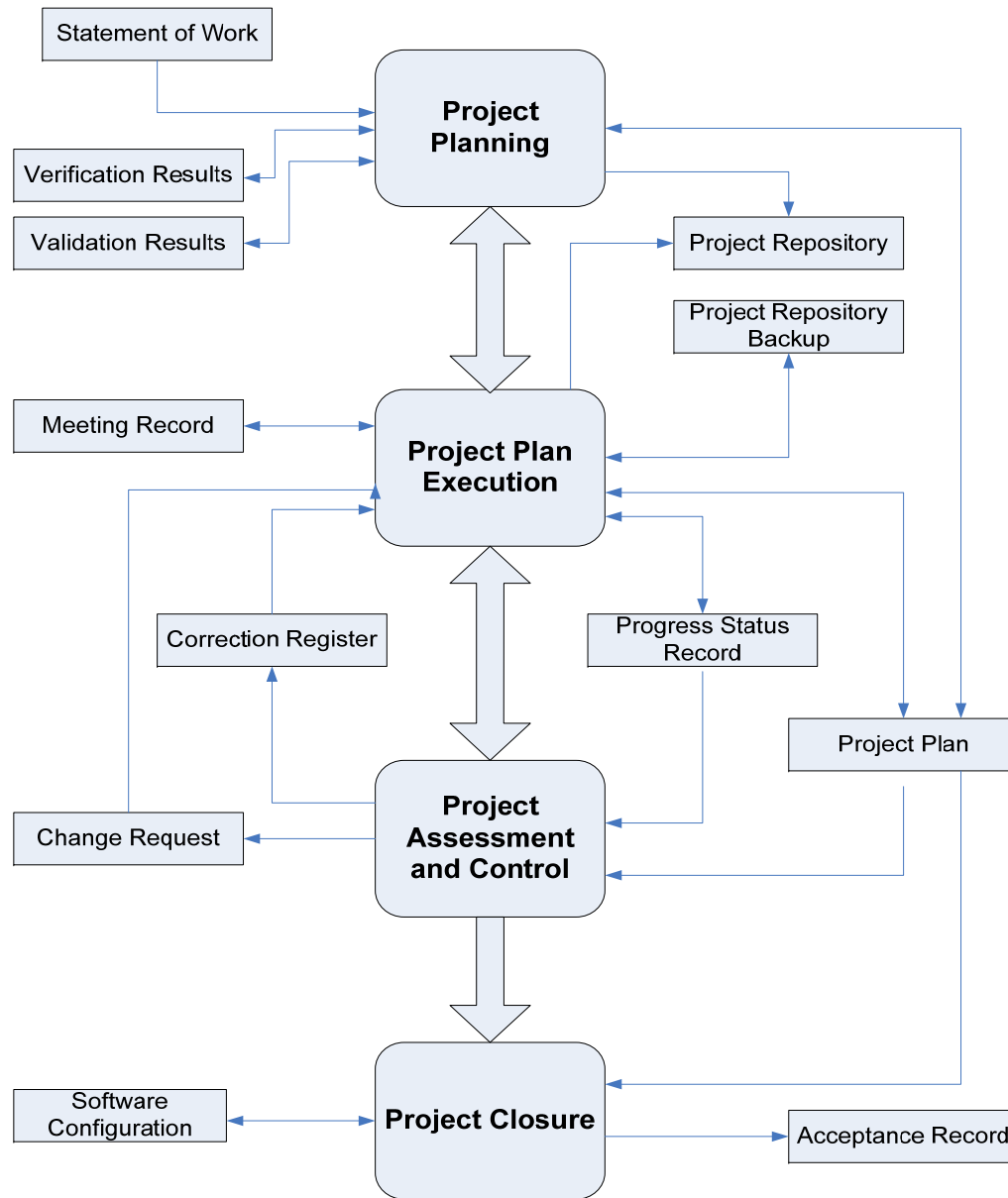

Part 5 - Software Implementation – 6 Activities

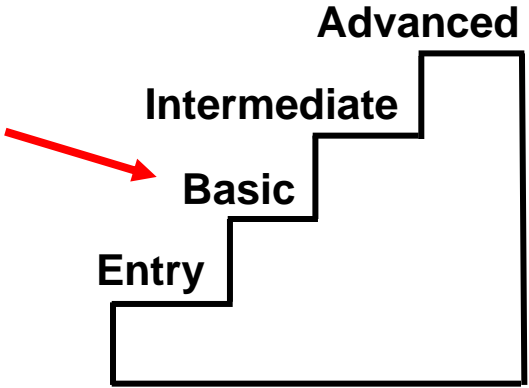
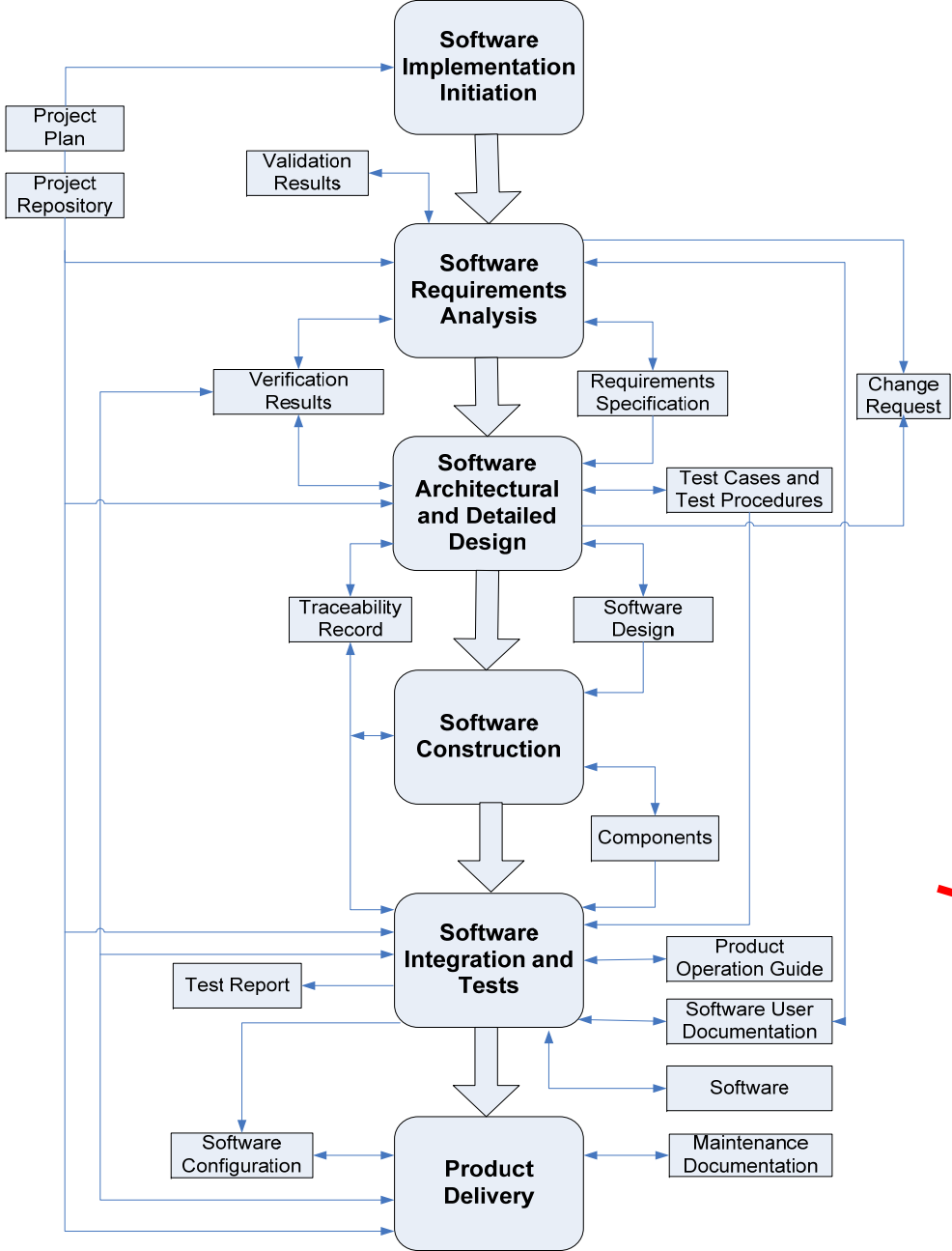

Agenda

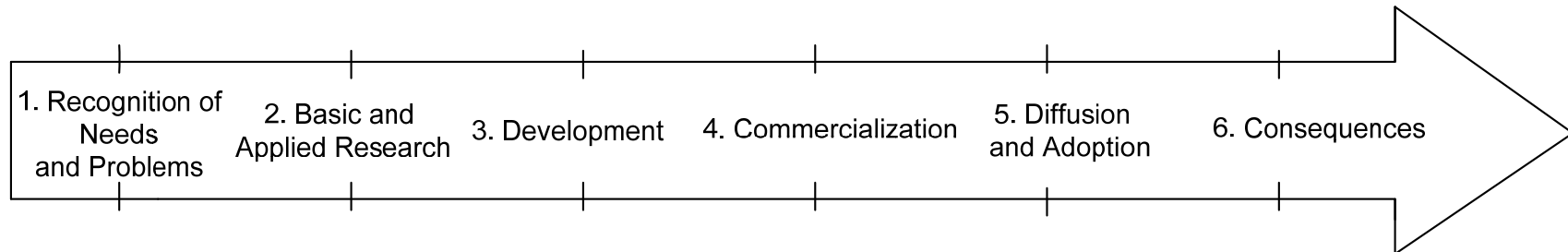

- **Phase 1 - Recognition of Needs and Problems (2004)**
- **Phase 2 - Basic and Applied Research (2005-2005)**
- **Phase 3 – Development (2006-2010)**
- • **Phase 4 – Commercialization (2010)**
- **Phase 5 - Diffusion and Adoption**
 - Development of the Means to Accelerate the Adoption and Utilization of International Standards by VSEs (2006 -)
- **Phase 6 - Consequences (2010 -)**

4. Commercialization

ISO Standard Development Process

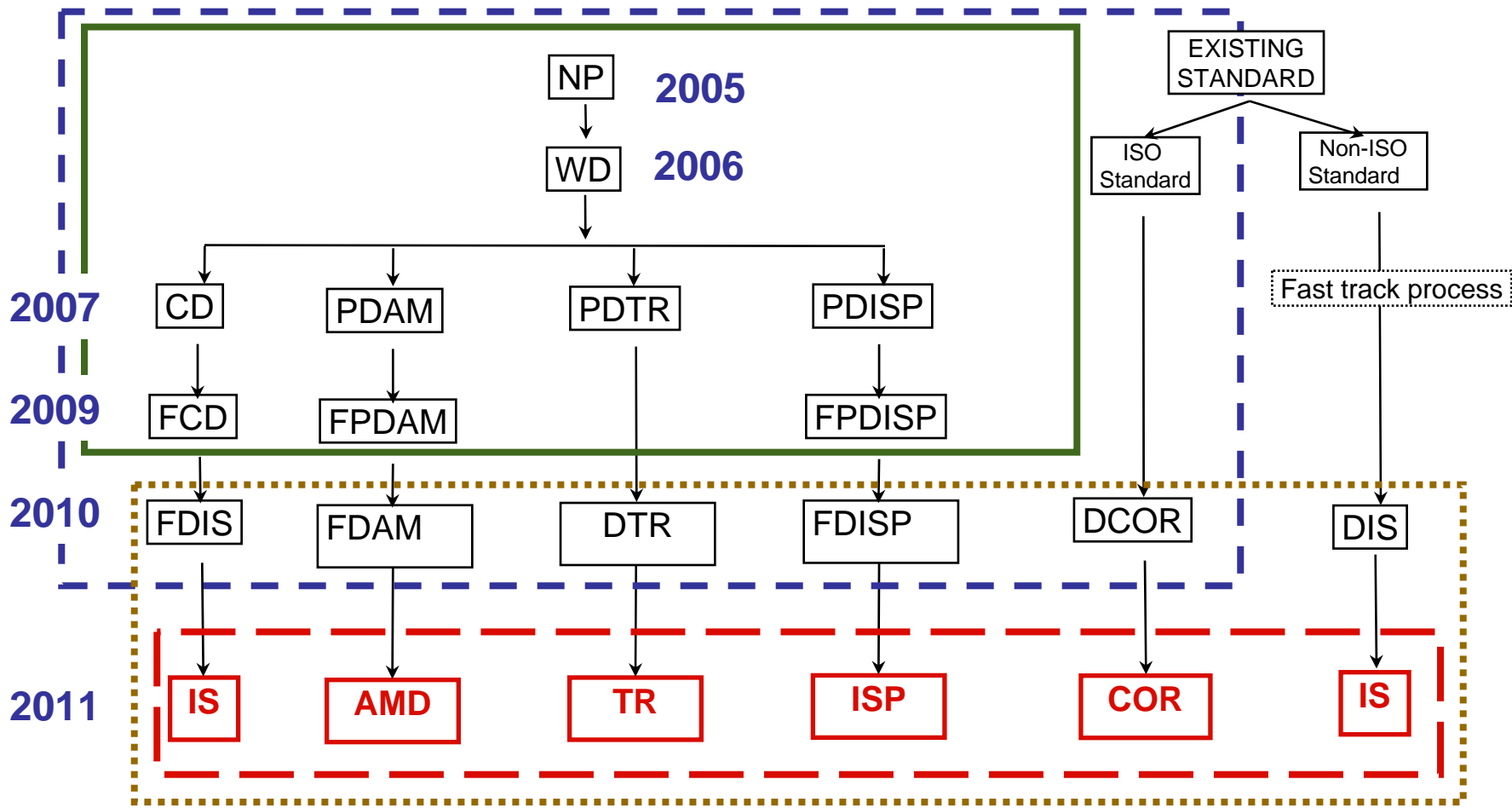

- - - SC7 develops
- SC7 controls
- - - ISO controls
- - - ISO edits and publishes

Adapted from: SC7 Secretariat Training for ISO Editors, Hyderabad 2009

Publication by ISO and Diffusion/Adoption

- **Commercialization begins when ISO publishes the Standard**
 - ISO Working Groups are not involved in commercialization
- **Needs of VSEs (from Survey)**
 - Not completely fulfilled with ISO/IEC 29110 Part 5 - Engineering and Management Guide
 - VSEs requested readily usable process with templates, checklists, etc.
- **The Concept of Deployment Packages (DPs)**
 - To accelerate diffusion and adoption worldwide
 - By providing readily usable information and made freely available.
 - Linked to ISO/IEC 29110 document
 - Part 5 - Annex A

Agenda

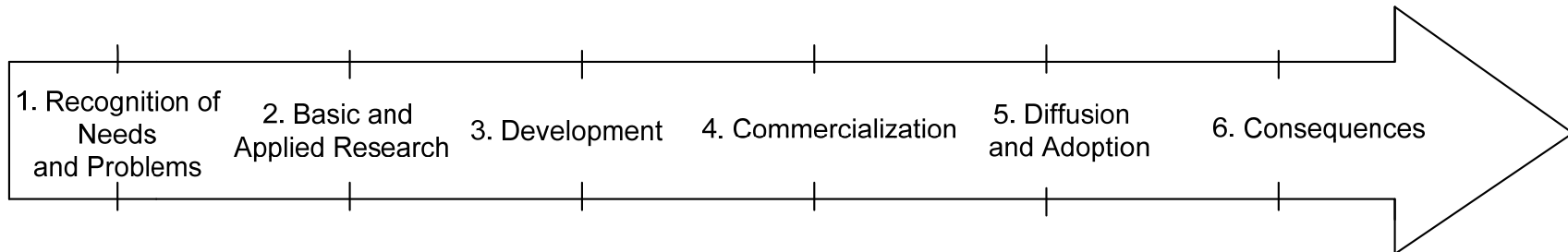

- **Phase 1 - Recognition of Needs and Problems (2004)**
- **Phase 2 - Basic and Applied Research (2005-2005)**
- **Phase 3 – Development (2006-2010)**
- **Phase 4 – Commercialization (2010)**
- **Phase 5 - Diffusion and Adoption (2006 -)**
 - Development of the Means to Accelerate the Adoption and Utilization of International Standards by VSEs (2006 -)
- **Phase 6 - Consequences (2010 -)**

Commitment Curve and the Adoption of a Technology - Standard

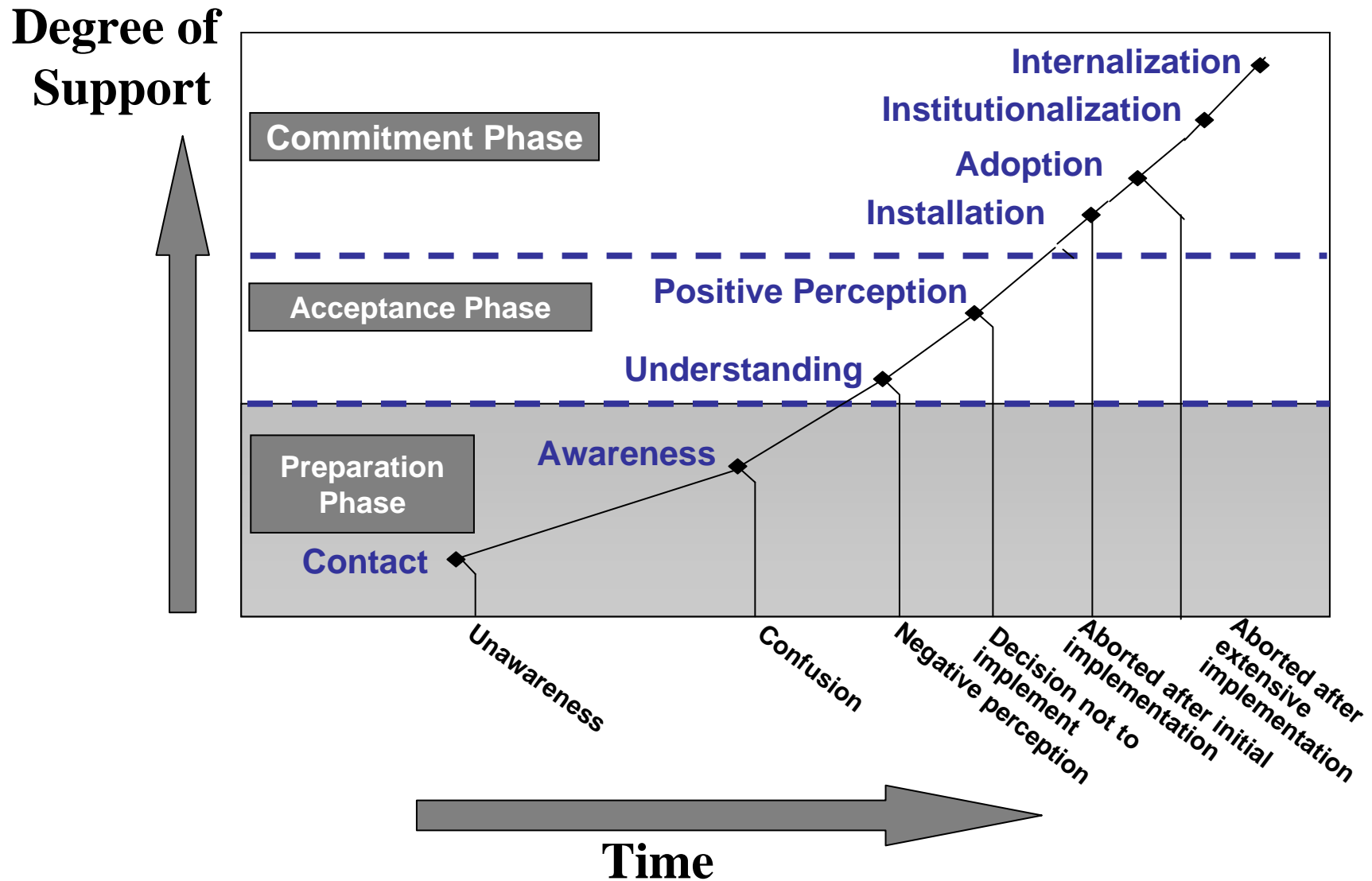

5. Diffusion

Rate of Diffusion/Adoption

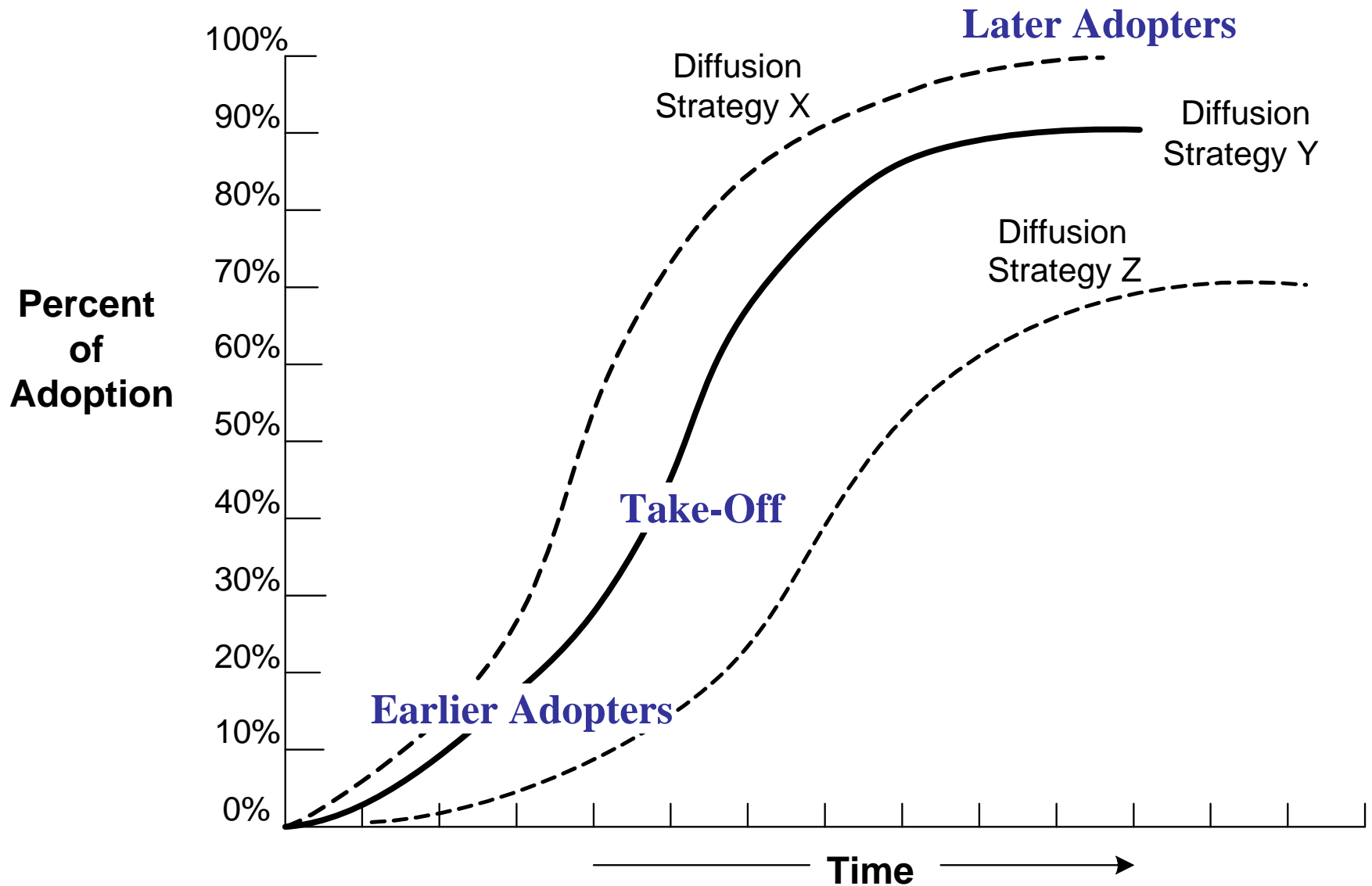

Deployment Packages (DPs)

- A Deployment Package (DP) is a set of artifacts developed to facilitate the implementation of a set of practices, of the selected framework, in a VSE.
 - A deployment package is not a complete process reference model. Deployment packages are not intended to preclude or discourage the use of additional guidelines that VSEs find useful.
- By deploying and implementing a Deployment Package, a VSE can see its concrete step to achieve or demonstrate coverage to Part 5.
- Deployment Packages are designed such that a VSE can implement its content, without having to implement the complete framework at the same time.
- Each DP is reviewed and edited by at least 2 persons
 - Ana Vasquez (Mexico)
 - Claude Y Laporte (Canada)

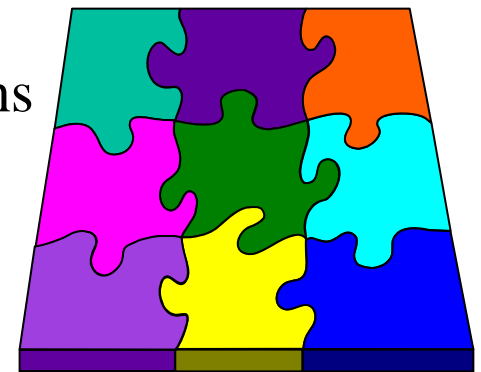

Content of Deployment Packages

1. Technical Description

Purpose of this document

Why this topic is Important ?

2. Definitions

Generic Terms

Specific Terms

3. Relationships with ISO/IEC 29110 Part 5-1

4. Description of Processes, Activities, Tasks, Steps, Roles and Products

5. Template

6. Example

7. Checklist

8. Tool

9. Reference to Standards and Models: ISO 9001, ISO/IEC 12207, CMMI

10. References

11. Evaluation Form

Deployment Packages are free !

Deployment Packages for the Basic Profile

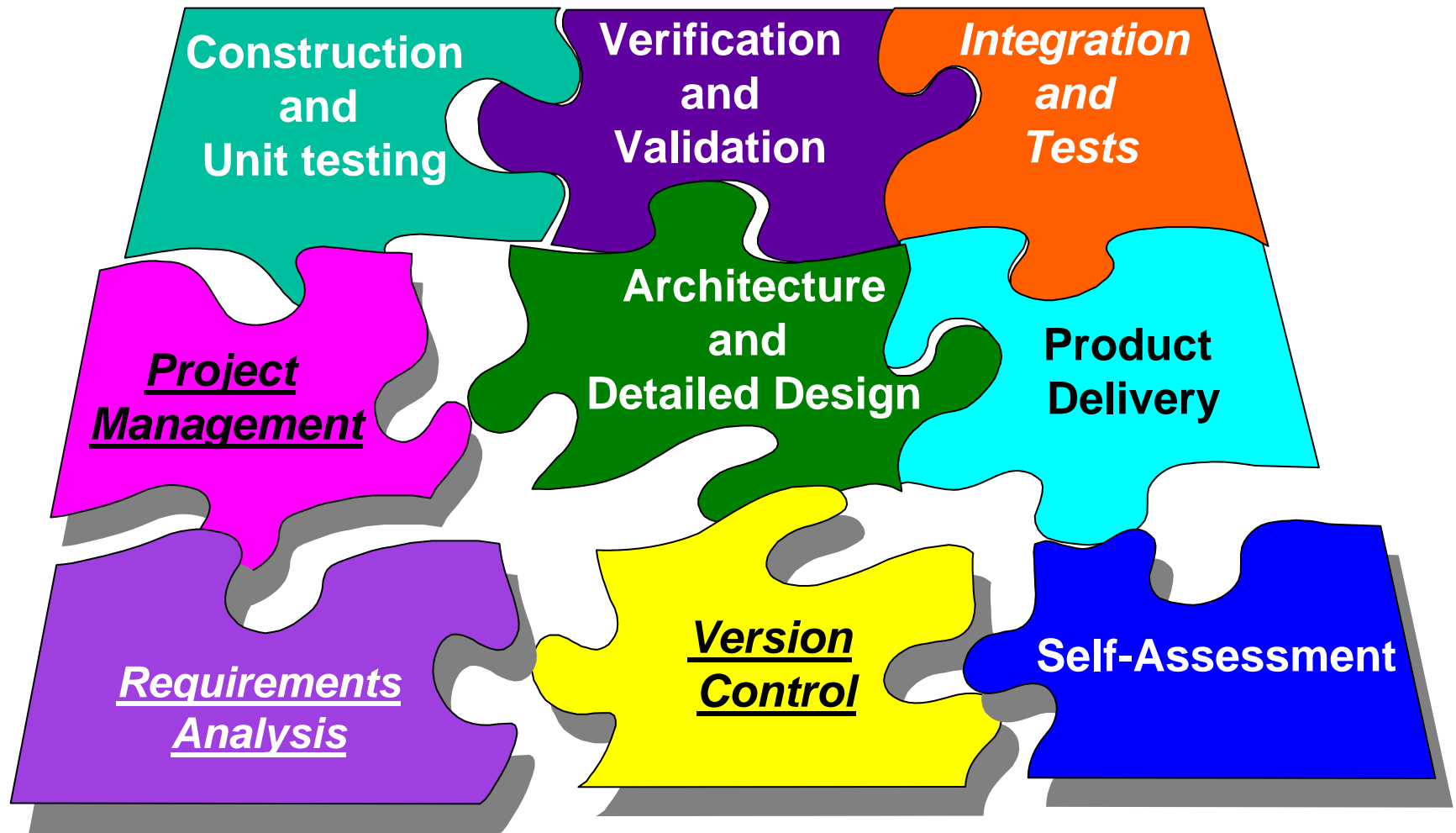

Deployment Packages for the Basic Profile

Title of Deployment Package	Developed by
Requirements Analysis	Belgium, Canada
Architecture and Detailed Design	Canada
Construction and Unit Testing	Mexico
Integration and Test	Columbia
Verification and Validation	Canada
Version Control	Thailand
Project Management	Ireland
Product Delivery	Canada
Self-Assessment	Finland

- **Additional DP:** Conduct of Pilot Projects DP (Canada, Uruguay) *



Pilot Projects

- **Definition**

- A method for exploring the value of a new technological concept via an objective study conducted in a somewhat realistic setting (adapted from Glass 1997).

- Successful pilot project is also an effective means of building adoption of new practices by members of a VSE *

- To be credible, the pilot projects should satisfy the following requirements (Fenton 1994):

- The pilot project experiment has to be designed correctly,

- The pilot project has to be performed in a real situation.

- It is not a toy project, i.e. an artificial problem in an artificial situation,

- The measurements have to be appropriate to the goals of the experiment,

- The experiment has to be run for long enough.

* To develop a solid business case to promote the adoption of ISO 29110 by VSEs internationally

Select and Conduct Pilot Project Deployment Package

- **Purpose**

- To provide tailorable and usable guidelines and materials in order to select and conduct pilot projects in VSEs.

- **Overview of the Tasks**

- Task 1 - Assess the opportunity to conduct a pilot project *
- Task 2 - Plan the Pilot Project
- Task 3 - Conduct the Pilot Project
- Task 4 - Evaluate the Results of the Pilot Project

Task 1 - Assess the Opportunity to Conduct a Pilot Project

- **Goals**

- The pilot project coordinator and the management of the VSE assess the opportunity to conduct a pilot project.
- If the conclusion of the assessment is positive, the commitment of VSE's management to conduct the pilot project is obtained.

- **Steps**

- Step 1: Sign the Confidentiality Agreement (optional)
- Step 2: Define the characteristics and context of the VSE
- Step 3: Define the problem(s) to be addressed
 - e.g. Perform an assessment using the Self-Assessment DP and tool
- Step 4: Select the technology to pilot
- Step 5: Select the project which will pilot the technology
- Step 6: Examine the cost and benefits of the pilot project
- Step 7: Obtain the commitment of VSE's management

Pilot Projects Completed in Canada

- **Pilot Project in a Computer Aided Design (CAD) Software Support Organisation**
 - Distributes and supports three types of software products:
 - Computer Aided Design, Computer Aided Manufacturing and Computer Aided Engineering.
 - Products serve mainly the aerospace and the automobile industries.
 - Defined the tasks of 4 developers and undertook to improve the following processes:
 - Project management, Software configuration management, Issue tracking and Requirements management
- **Project conducted at a School Board of the Montréal Area**
 - Provide a stimulating environment for student learning.
 - It represents 54 primary schools, 14 secondary schools, 2 general training centers and 4 vocational training centers.
 - Over 8,000 employees,
 - IT department with a staff of 4: 1 analyst and 3 developers.
 - Studied, translated and implemented 3 DPs:
 - Software Requirements, Version Control, Project Management

Pilot Projects Underway

- **Belgium (CETIC)**
 - VSE of 25 people have developed a solution for managing Tram / bus / subway tickets in Brussels.
 - Pilot project started in June with a process assessment phase aiming to identify strengths and weaknesses in development related processes.
 - CETIC is preparing, with this company, the improvement actions mainly based on the following Deployment Packages:
 - Requirement Analysis, Version Control, Project Management
- **France (UBO)**
 - VSE (ÉcoCompteur) and students of the Software Engineering Master
- **Ireland (LERO)**
 - VSE of 10 people who are involved in designing software solutions for a range of business types and in addition they have created an in-house development platform.

Pilot Projects Underway in Canada - 1

- **Pilot Project 1 - Centre of Excellence in Neuromics of Université de Montréal**
 - Graduate student in Software Engineering
 - Development of a software process for a research laboratory
 - Research software allows students to perform various laboratory experiments to understand the functioning of the brain areas used for listening and recognition of sounds.
- **Pilot Project 2 - Gemalto Company**
 - Security and cryptography Company
 - Graduate student in Software Engineering
 - Working for the Organisation as Manager of Embedded System Development
- **Pilot Project 3 – in 3 VSEs**
 - Will perform assessments and deployment of DPs
- **Pilot Projects 4 – in 1 VSE**
 - Senior undergraduate student in software engineering at ETS

Pilot Projects Underway in Canada - 2

- **Software Engineering Graduate students – SQA Course ***
 - **AXA Company**
 - French global insurance companies group headquartered in Paris.
 - IT staff of 11 in Montréal
 - Team of 5 students
 - **Notarius Company**
 - Support the notary profession's transition into a virtual environment
 - 3,200 notaries in Québec
 - Organisation of 70 people
 - IT staff of 8
 - Team of 3 students
 - **ESRI Canada Limited**
 - World leader in GIS (geographic information system) modeling and mapping software and technology
 - Organisation of 1000 employees
 - IT staff of 6 in Montréal
 - Team of 5 students

Pilot Projects Underway in Canada - 3

- **Software Engineering Graduate students – SQA Course***
 - **Barreau du Québec (Corporation of Lawyers)**
 - Team of 4 students
 - **ERPsim Lab**
 - University Research Laboratory of a Business School
 - ERP simulation (e.g. SAP)
 - Team of 4 students

Network of Support Centers for VSEs

- **Objectives**

- Help accelerate the development of ISO standard for VSEs
 - Accelerate deployment of VSE Standard
 - Accelerate the development and application of Deployment Packages
-

- Belgium (Cetic)



- Canada (ÉTS)



- Colombia (Parquesoft)



- Finland



- France (UBO)



- Hong Kong



- Ireland (LERO)



- Luxembourg (Tudor Research Center)



- Mexico

- Thailand (Institute of Software Promotion for Industries)

Thailand Initial Implementation

ISO29110-VSE Model



Dr. Anukul Tamprasirt
Mr. Prakrit Sangpa
Dr. Sujimarn Suwannaroj
Mr. Tanin Utayanaka

ISO29110-VSE Collaboration

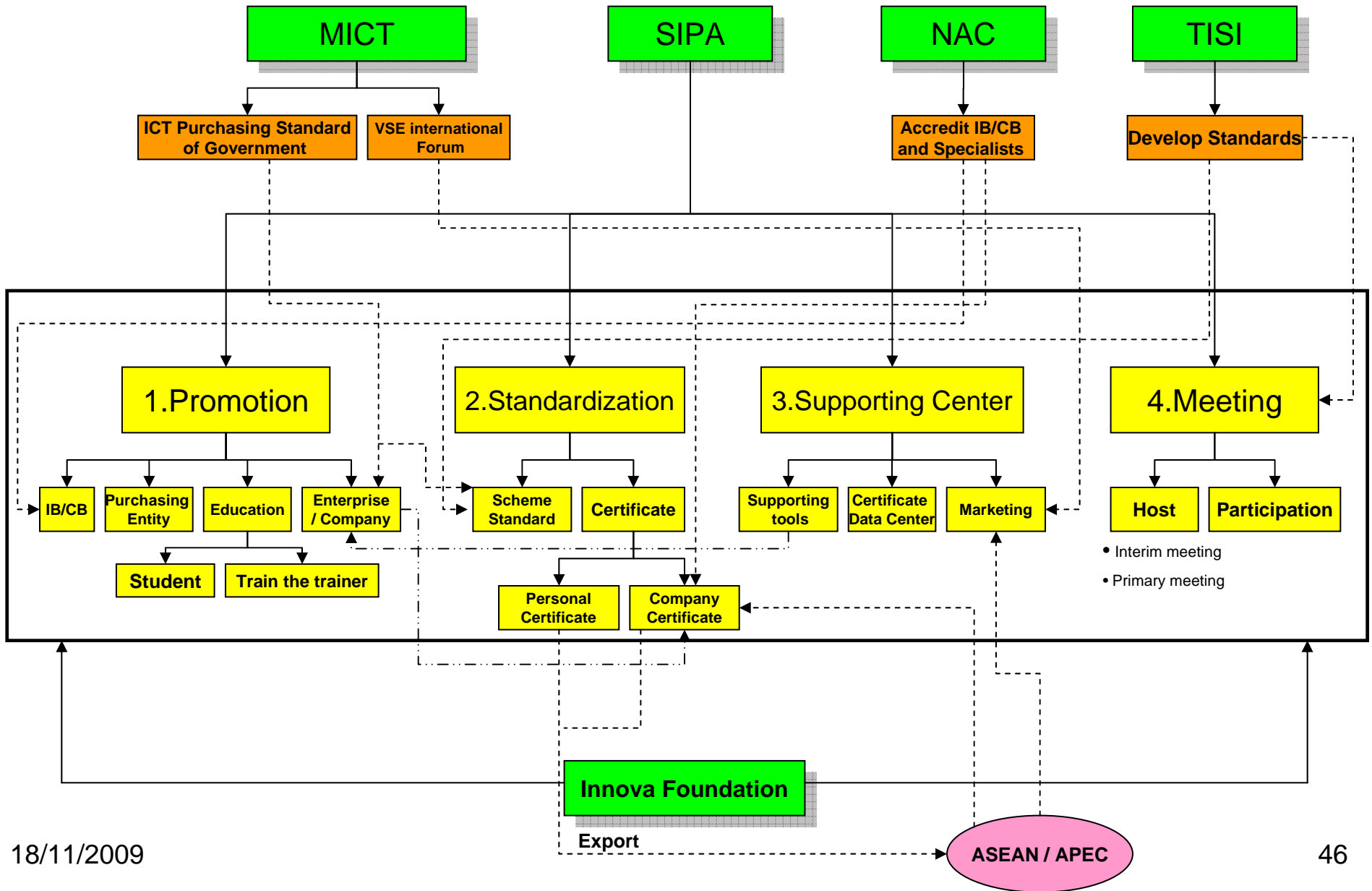

Education Interest Group

- Proposed at the Hyderabad meeting (May 2009)
 - To help educators teach the future ISO standards for VSEs by developing and providing at no cost educational material,
 - To sensitize undergraduate and graduate students to the ISO standard for VSEs.
- Courses to Support ISO 29110 Standards and Technical reports
 1. Introduction to ISO/IEC Software Engineering Standards ([Ireland](#))
 2. Introduction to the ISO/IEC 29110 Standards, Technical Reports and Deployment Packages for VSEs ([Canada](#))
 3. Development of a Software engineering Process using ISO/IEC 29110 TR Part 5 – Engineering and Management Guide
 4. Software Development Using ISO/IEC 29110 TR - Engineering and Management Guide ([Czech Republic](#))
 5. Self-Assessment of an ISO/IEC 29110-Based Software Process
 6. Conduct Deployment of ISO/IEC Standard in a VSE ([Canada](#))

<http://profs.logti.etsmtl.ca/claporte/English/VSE/VSE-Education.html>

Development of a Public Web Site

- **Process Asset Library**

- An organized, indexed, searchable, and downloadable repository of process assets that is easily accessible by everyone who needs processes and process-related assets, such as Deployment Packages.



Technology transfer center for VSEs at the ÉTS

- **Mission**

- To accelerate technology transfer to small and very small structures in Québec developing software products or software-based systems, or to provide IT services to make them more competitive, both at the national level and internationally, by developing and deploying software engineering practices tailored to their needs.

- **Objectives**

1. Identify, promote, and disseminate best practices in software engineering and services for very small entities;
2. Accelerate the process of technology transfer in software engineering for VSEs;
3. Provide information and technical and strategic information to managers of VSEs, outsourcers, and Government of Québec agencies;
4. Participate in the development of international standards for VSEs;
5. Promote international standards for VSEs in Québec;
6. Promote research in software engineering for VSEs;
7. Promote training and development courses on ISO standards for VSEs.

Agenda

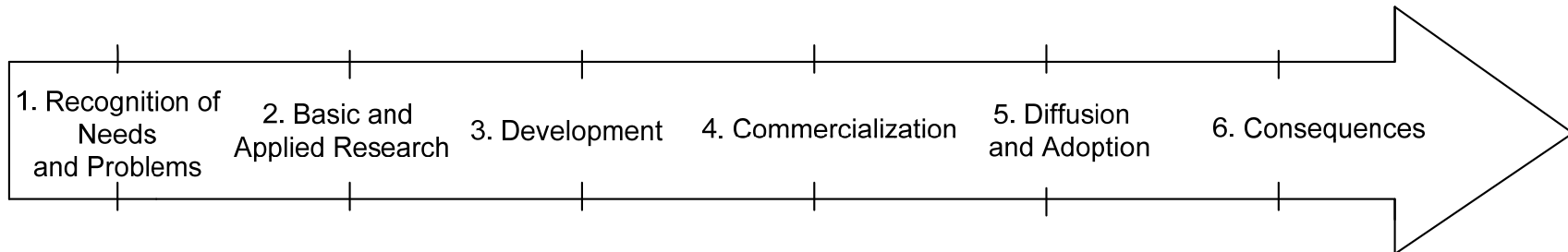

- **Phase 1 - Recognition of Needs and Problems (2004)**
- **Phase 2 - Basic and Applied Research (2005-2005)**
- **Phase 3 – Development (2006-2010)**
- **Phase 4 – Commercialization (2010)**
- **Phase 5 - Diffusion and Adoption (2006 -)**
- • **Phase 6 - Consequences (2010 -)**

Consequences

- Promoters of an innovation are often optimistic
 - Change agents and agencies tacitly assume that the consequences of innovations will be positive.
- The consequences of an innovation usually manifest themselves over extended periods of time (e.g. months, years)
- Possible consequences (undesirable, direct or indirect, anticipated or unanticipated)
 - Imposing the standards on all the VSEs in a country or on all a customer's VSEs
 - e.g. from a large enterprise or a government agency
 - Not imposing the standards on VSEs (*laissez-faire*)

Next Steps

- Develop the remaining 3 profiles
 - **Entry**: six person-months effort or start-up VSEs
 - **Intermediate**: Management of more than one project
 - **Advanced**: business management and portfolio management practices.
- Develop profiles for other domains
 - Critical software: e.g. medical, aerospace,
 - Scientific software development
- Development of self-learning course modules to support DPs
- Development of plug-in modules (e.g. Eclipse) to support DPs

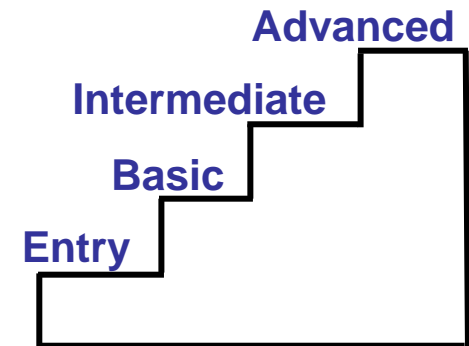

Proposed Entry Profile

- **VSEs Targeted by the Entry Profile**
 - VSEs working on small projects
 - e.g. at most six person-months effort
 - Start-up VSEs.

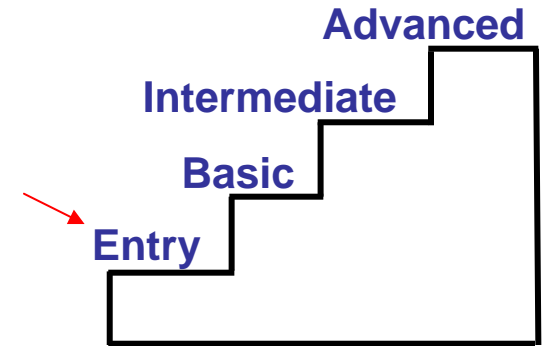

- **Objectives**
 - The Entry Profile could be used by recently established VSEs
 - i.e. as a ‘start-up kit’
 - The Entry Profile provides a foundation for a migration to the Basic Profile.

Proposed Entry Profile

- **Processes**

- **Project Planning and Monitoring Process**

- Develop an agreement of product to develop
 - Develop a project plan
 - Monitor project status and perform reviews

- **Software Development Process**

- Analyze and Document the Requirement
 - Document the Design
 - Code and Test

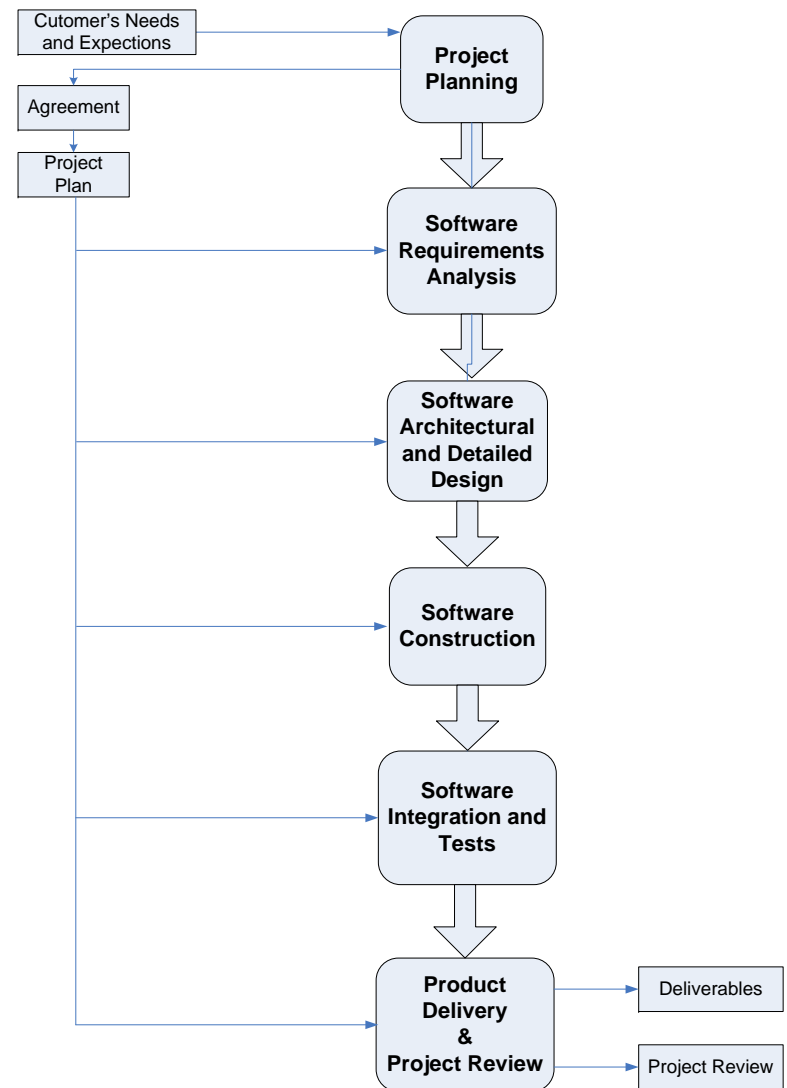

Two Additional Stages *

- **Management of more than one project**
- **Additional practices**
 - Quality assurance
 - Configuration management
 - Version management is done at Stage 2
 - Testing
 - Improved Integration and Acceptance testing
 - Other Practices (to be determined)
 - Supplier management
 - Measurement
 - Business Management
 - To help the VSE to grow its business

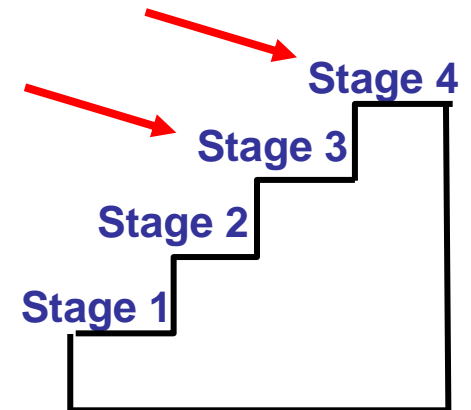

Development of Profiles and DPs in Systems Engineering

Project done under sponsorship of INCOSE/AFIS

- International Council on Systems Engineering (INCOSE)
- Association Française d'ingénierie système (AFIS)

Goals

- To improve or make product development efficient by using Systems Engineering methodology
- To elaborate tailored practical guidance to apply to VSMEs in the context of prime or subcontractor, of commercial products
- To contribute to standardization

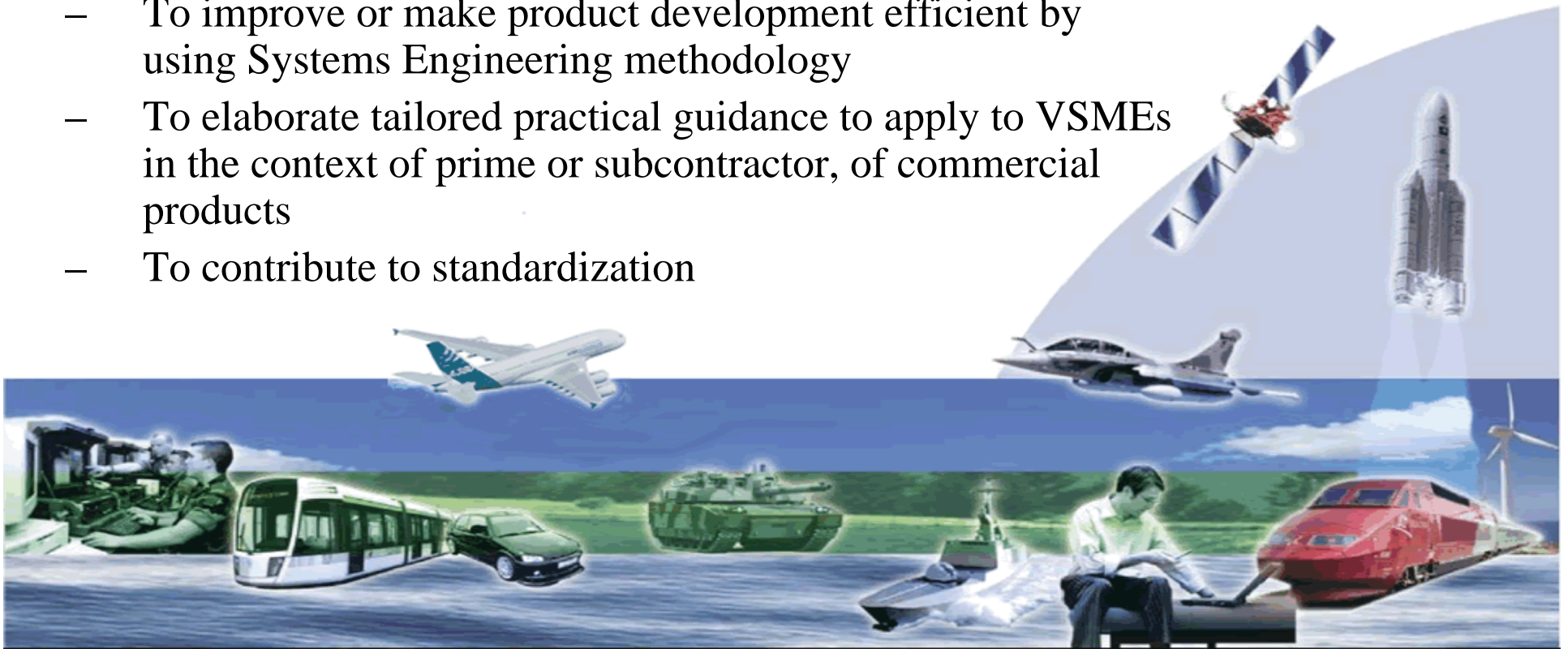

Contact Information

- **Claude Y Laporte**

- **Voice: + 1 514 396 8956**

- **E-Mail: Claude.Y.Laporte@etsmtl.ca**

- **Web: www.logti.etsmtl.ca/profs/claporte**

- **Public site of WG 24**

- **Free access to Deployment Packages and articles**

- <http://profs.logti.etsmtl.ca/claporte/English/VSE/index.html>